

PRODUCT SHEET

Description:

Cam Lock 1816, 90DG, Cam No. 9, CPL, MK CPH,80 KD,W/2 Tran parent Washers, W/Steel Spike Washer

Item number:

14.04.468-5

Units	Box	Carton	HS Code	Barcode
Pcs.	12	120	8301300000	
				5704866453639

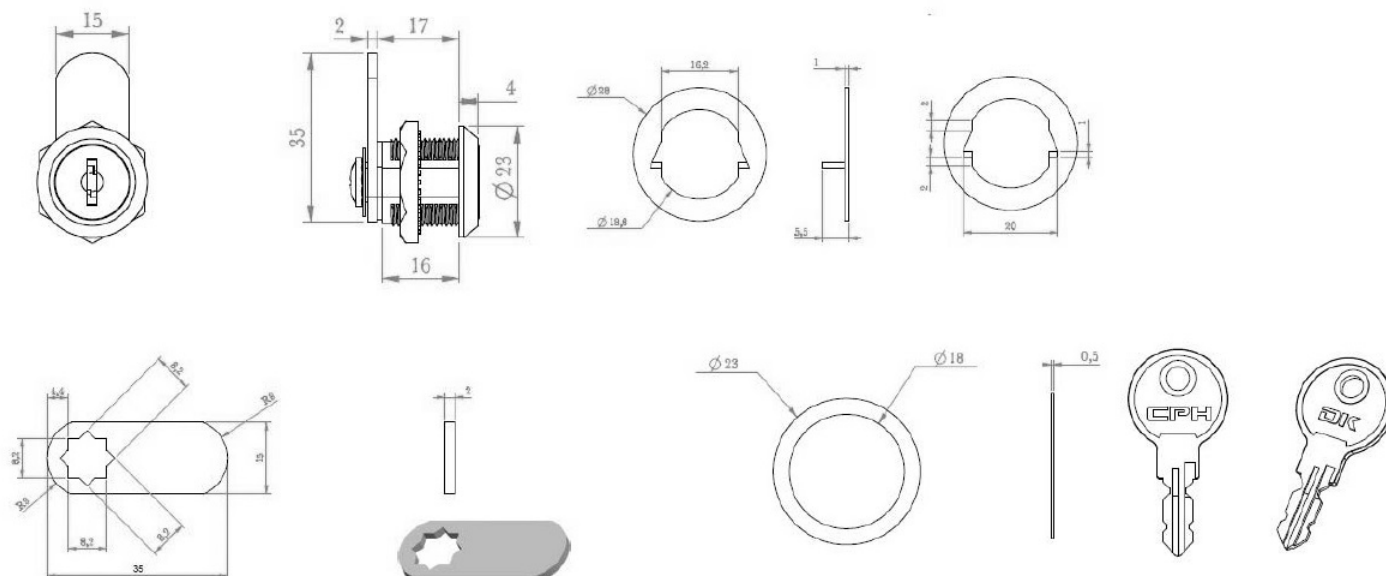

SISO A/S

Mileparken 11
DK-2740 Skovlunde
Denmark
VAT: DK 24786013

Phone +45 45 830 900

www.siso.dk
siso@siso.dk

Danske Bank
Nytorv Branch
Copenhagen
SWIFT: DABADKKK

Account no.
4180 3112 112936
IBAN Account
DK7230003112112936